

Series  
**VENTS KSK**



Centrifugal kitchen fan in sound-insulated casing with air flow up to **8138 m³/h**

■ **Application**

The fan is designed for ventilation of contaminated, grease-laden, humid and hot air with temperature up to 120 °C in conditions of high air resistance in the system. This fan model fits for the following applications:

- kitchen exhaust ventilation systems
- exhaust ventilation systems for removal of post-welding gases
- industrial bakery ventilation systems

■ **Design description**

The fan casing is made of galvanized steel plate and is internally insulated with 50 mm mineral wool layer. The swivel block of the impeller and motor provides easy access to the fan internals for easy and effective cleaning.

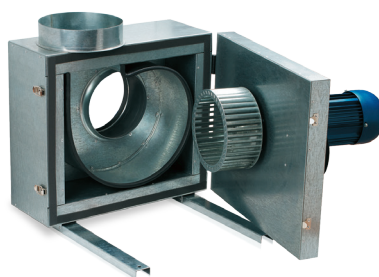

The intake and exhaust flange diameter match with standard ventilation air ducts. The flanges are equipped with a rubber sealing. The fan is installed in the mounting frames with integrated vibration connectors.

■ **Electric motor**

The fan is fitted with a reliable maintenance-free single-phase motor with short circuit rotor and a high-efficient steel centrifugal impeller. The motor is equipped with integrated thermal contacts with terminals leaded outside for connection to an external protection

device. The impeller is mounted on the motor shaft and is balanced statically and dynamically. The motor has F class motor winding insulation and IP54 ingress protection rating.

■ **Speed control**

The fan has both step and smooth speed control options with a transformer or frequency speed controller. Several fans may be connected to one controller if the total power and operating current do not exceed the rated controller parameters.

■ **Mounting**

The fan is designed for connection to round air ducts. The fan is fixed to the wall with the mounting bracket KM-KSK (separate delivery). The fan is connected to power mains on the terminal box on the motor. The cable length must be sufficient with respect to the motor-impeller block movement.

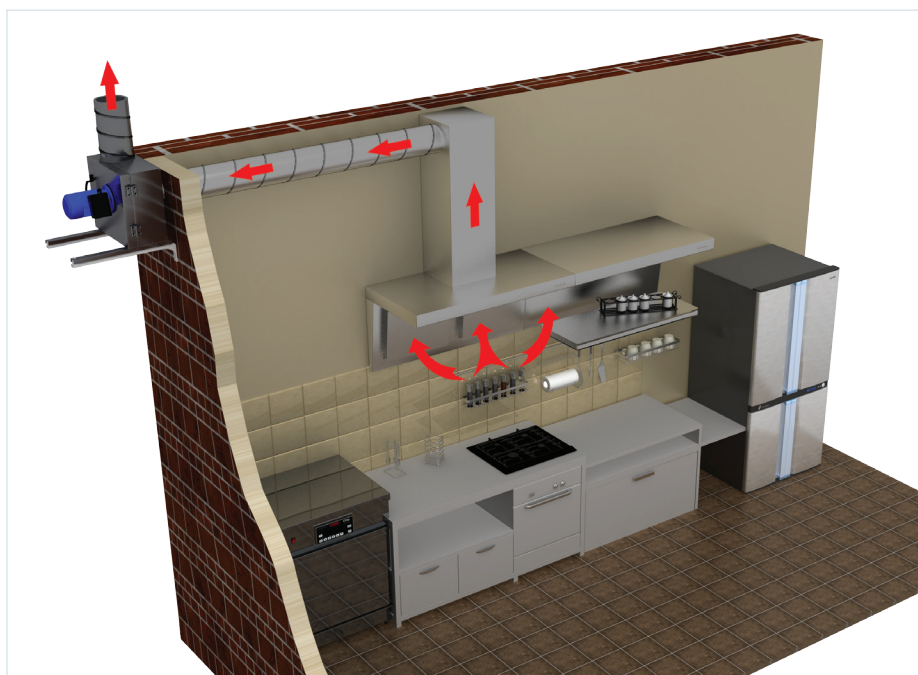

**Designation key:**

Fan series	Spigot diameter	Motor	
		Poles	Phase
<b>VENTS KSK</b>	150, 160, 200, 250, 315, 355, 400, 450	2	<b>E:</b> single-phase <b>D:</b> three-phase
		4	
		6	

**Accessories**



Backdraft damper



Speed controllers



Fixing bracket KM-KSK



Sleeve N-KSK

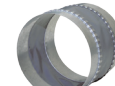

Flexible connector VH-KSK

**Technical data**

	KSK 150 4E KSK 160 4E	KSK 150 4D KSK 160 4D
Voltage [V/Hz]	230/50	400/50
Power [W]	180	180
Current [A]	1.7	0.6
Maximum air flow [m³/h]	700	730
RPM [min <sup>-1</sup> ]	1450	1455
Noise level at 3 m [dBA]	41	41
Maximum operating temperature [°C]	-20...+120	
Protection rating	IP54	

	KSK 200 4E	KSK 200 4D
Voltage [V/Hz]	230/50	400/50
Power [W]	550	750
Current [A]	3	2
Maximum air flow [m³/h]	1600	1650
RPM [min <sup>-1</sup> ]	1475	1465
Noise level at 3 m [dBA]	45	45
Maximum operating temperature [°C]	-20...+120	
Protection rating	IP54	

**VENTS KSK**

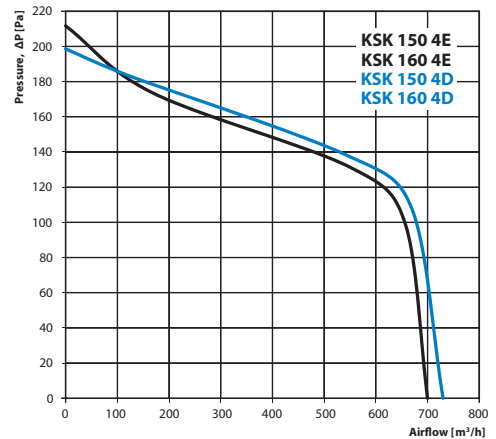

**KSK 150 4E**  
**KSK 160 4E**

Sound-power level, A-weighted	Hz	Sound power level, A-filter applied								Sound pressure level at 3 meters, A-filter applied LpA, 3m [dBA]	Sound pressure level at 1 meters, A-filter applied LpA, 1m [dBA]	
		Octave frequency band, Hz										
		General	63	125	250	500	1000	2000	4000			8000
L <sub>WA</sub> to inlet	dBA	80	65	78	74	71	66	64	59	55	60	70
L <sub>WA</sub> to outlet	dBA	82	58	81	76	73	68	66	62	57	62	72
L <sub>WA</sub> to environment	dBA	62	47	60	55	52	47	45	40	36	41	51

**KSK 150 4D**  
**KSK 160 4D**

Sound-power level, A-weighted	Hz	Sound power level, A-filter applied								Sound pressure level at 3 meters, A-filter applied LpA, 3m [dBA]	Sound pressure level at 1 meters, A-filter applied LpA, 1m [dBA]	
		Octave frequency band, Hz										
		General	63	125	250	500	1000	2000	4000			8000
L <sub>WA</sub> to inlet	dBA	79	59	77	73	70	66	64	59	55	59	69
L <sub>WA</sub> to outlet	dBA	81	71	79	75	71	67	65	61	57	61	71
L <sub>WA</sub> to environment	dBA	61	44	59	55	51	47	45	41	36	41	51

**VENTS KSK**

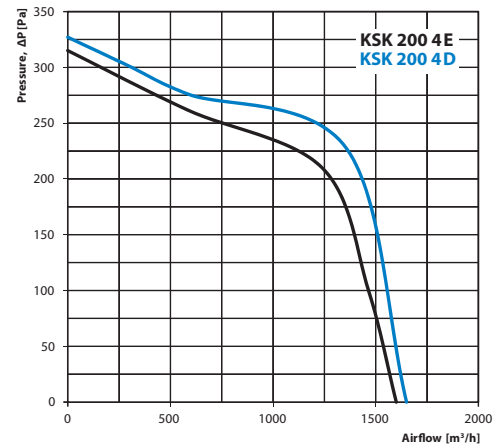

**KSK 200 4E**

Sound-power level, A-weighted	Hz	Sound power level, A-filter applied								Sound pressure level at 3 meters, A-filter applied LpA, 3m [dBA]	Sound pressure level at 1 meters, A-filter applied LpA, 1m [dBA]	
		Octave frequency band, Hz										
		General	63	125	250	500	1000	2000	4000			8000
L <sub>WA</sub> to inlet	dBA	85	69	83	78	75	70	68	63	58	65	75
L <sub>WA</sub> to outlet	dBA	86	61	85	80	76	72	69	65	60	66	76
L <sub>WA</sub> to environment	dBA	66	50	64	59	55	50	48	43	38	45	55

**KSK 200 4D**

Sound-power level, A-weighted	Hz	Sound power level, A-filter applied								Sound pressure level at 3 meters, A-filter applied LpA, 3m [dBA]	Sound pressure level at 1 meters, A-filter applied LpA, 1m [dBA]	
		Octave frequency band, Hz										
		General	63	125	250	500	1000	2000	4000			8000
L <sub>WA</sub> to inlet	dBA	84	63	82	78	74	70	67	63	58	64	74
L <sub>WA</sub> to outlet	dBA	86	76	84	80	76	72	70	65	61	66	76
L <sub>WA</sub> to environment	dBA	66	50	64	59	55	50	48	43	38	45	55

## SOUND-INSULATED KITCHEN FAN

	KSK 250 4E	KSK 250 4D
Voltage [V/Hz]	230/50	400/50
Power [W]	1500	1500
Current [A]	11	3.4
Maximum air flow [m <sup>3</sup> /h]	3400	3500
RPM [min <sup>-1</sup> ]	1500	1470
Noise level at 3 m [dBA]	51	51
Maximum operating temperature [°C]	-20...+120	
Protection rating	IP54	

	KSK 315 4E	
Voltage [V/Hz]	230/50	230/60
Power [W]	304	383
Current [A]	1.84	1.72
Maximum air flow [m <sup>3</sup> /h]	1970	2310
RPM [min <sup>-1</sup> ]	1475	1750
Noise level at 3 m [dBA]	46	47
Maximum operating temperature [°C]	-20...+120	
Protection rating	IP54	

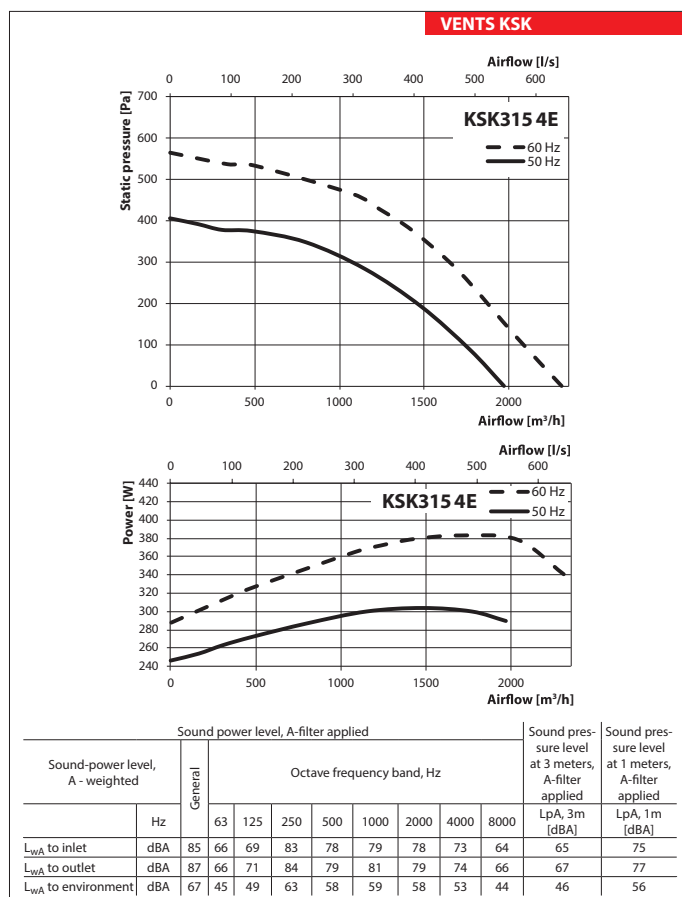
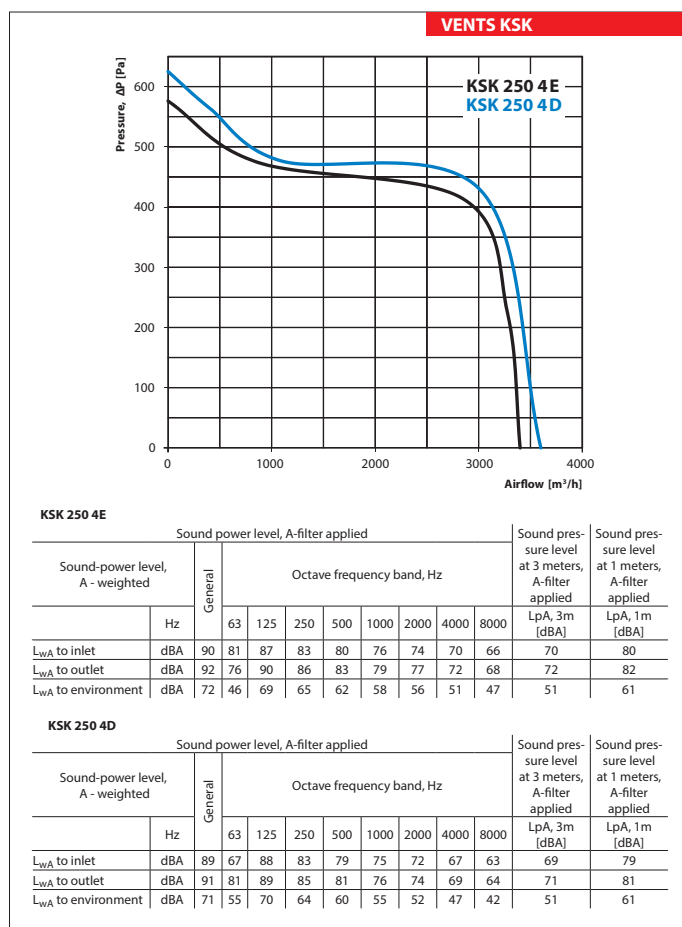

	KSK 315 4D	
Voltage [V/Hz]	400/50	400/60
Power [W]	184	206
Current [A]	0.70	0.70
Maximum air flow [m³/h]	2040	2355
RPM [min⁻¹]	1488	1776
Noise level at 3 m [dBA]	46	48
Maximum operating temperature [°C]	-20...+120	
Protection rating	IP54	

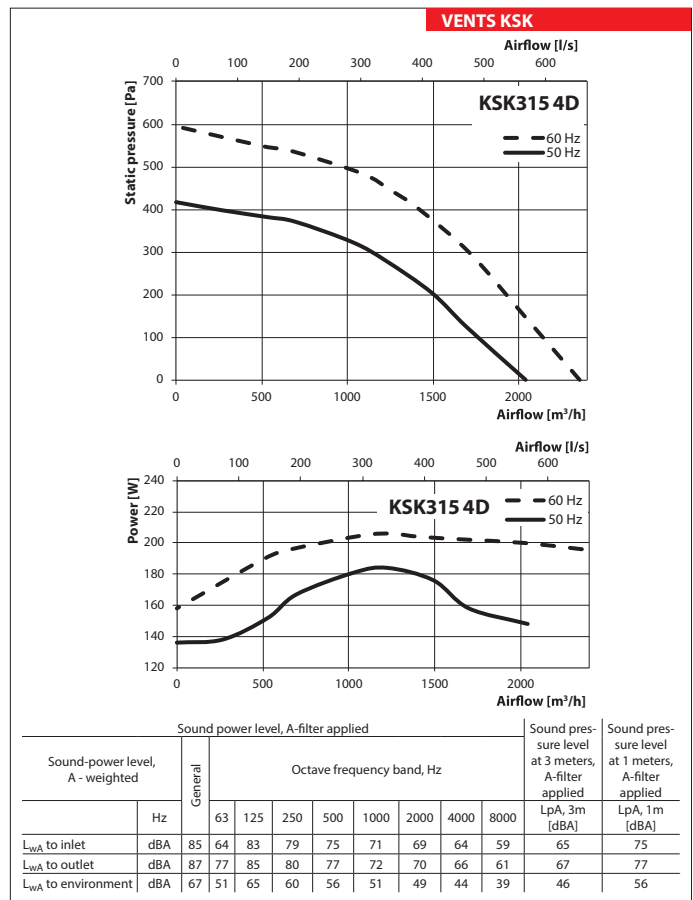

	KSK 315 2E	
Voltage [V/Hz]	230/50	230/60
Power [W]	1531	2816
Current [A]	7.35	11.92
Maximum air flow [m³/h]	4695	5345
RPM [min⁻¹]	3125	3384
Noise level at 3 m [dBA]	53	55
Maximum operating temperature [°C]	-20...+120	
Protection rating	IP54	

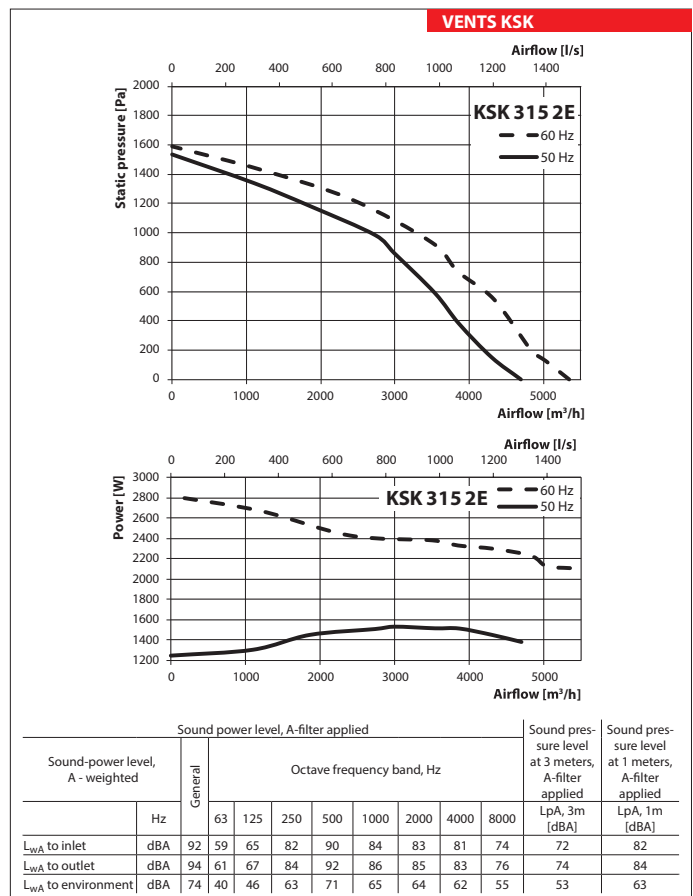

## SOUND-INSULATED KITCHEN FAN

	KSK 315 2D	
Voltage [V/Hz]	400/50	400/60
Power [W]	1225	2011
Current [A]	2.80	3.40
Maximum air flow [m³/h]	4710	5290
RPM [min <sup>-1</sup> ]	3025	3328
Noise level at 3 m [dBA]	52	54
Maximum operating temperature [°C]	-20...+120	
Protection rating	IP54	

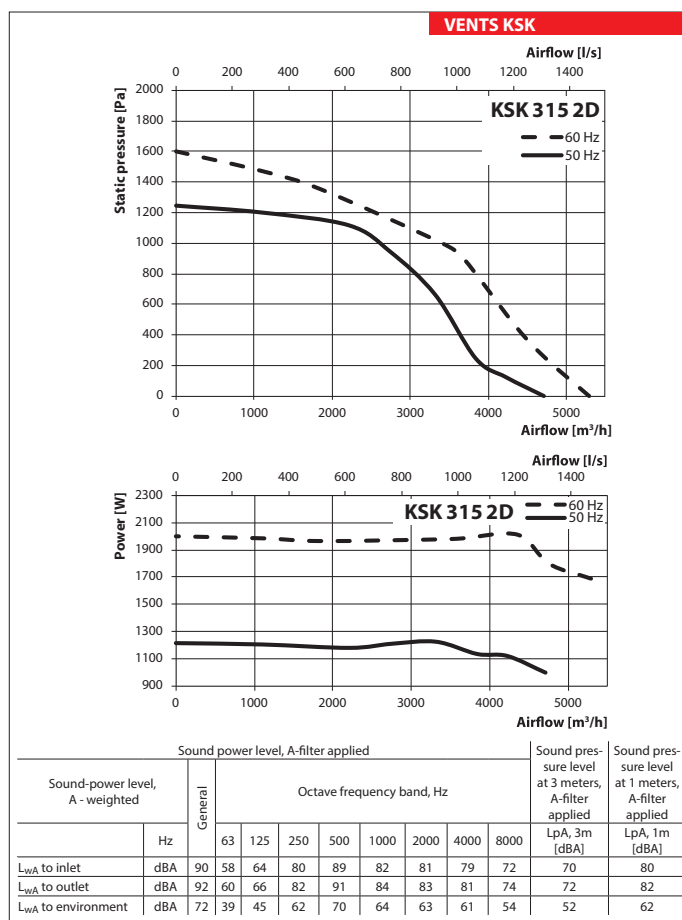

	KSK 355 4E	
Voltage [V/Hz]	230/50	230/60
Power [W]	393	525
Current [A]	2.11	2.34
Maximum air flow [m³/h]	3545	3860
RPM [min <sup>-1</sup> ]	1517	1705
Noise level at 3 m [dBA]	50	52
Maximum operating temperature [°C]	-20...+120	
Protection rating	IP54	

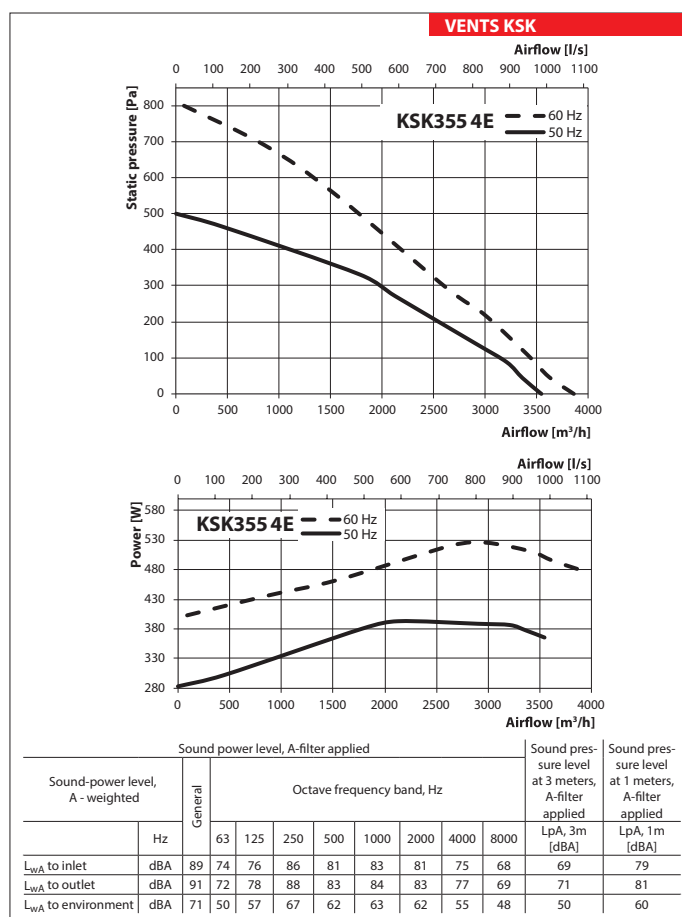

	KSK 355 4D	
Voltage [V/Hz]	400/50	400/60
Power [W]	405	580
Current [A]	0.87	1.25
Maximum air flow [m³/h]	3155	3270
RPM [min <sup>-1</sup> ]	1379	1578
Noise level at 3 m [dBA]	49	50
Maximum operating temperature [°C]	-20...+120	
Protection rating	IP54	

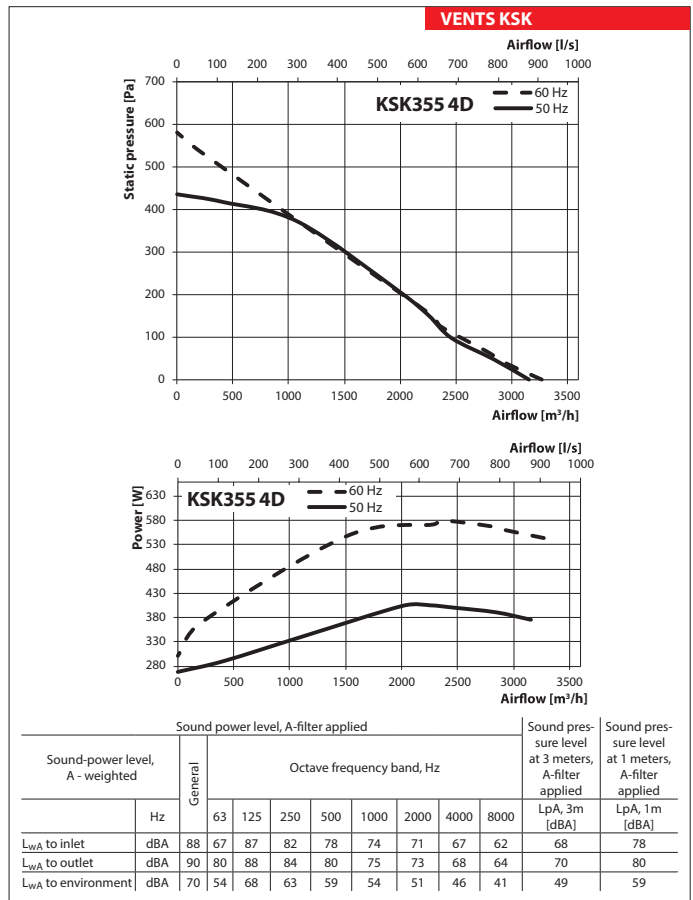

	KSK 355 2E
Voltage [V/Hz]	230/50
Power [W]	2621
Current [A]	12.66
Maximum air flow [m³/h]	6570
RPM [min <sup>-1</sup> ]	2890
Noise level at 3 m [dBA]	54
Maximum operating temperature [°C]	-20...+120
Protection rating	IP54

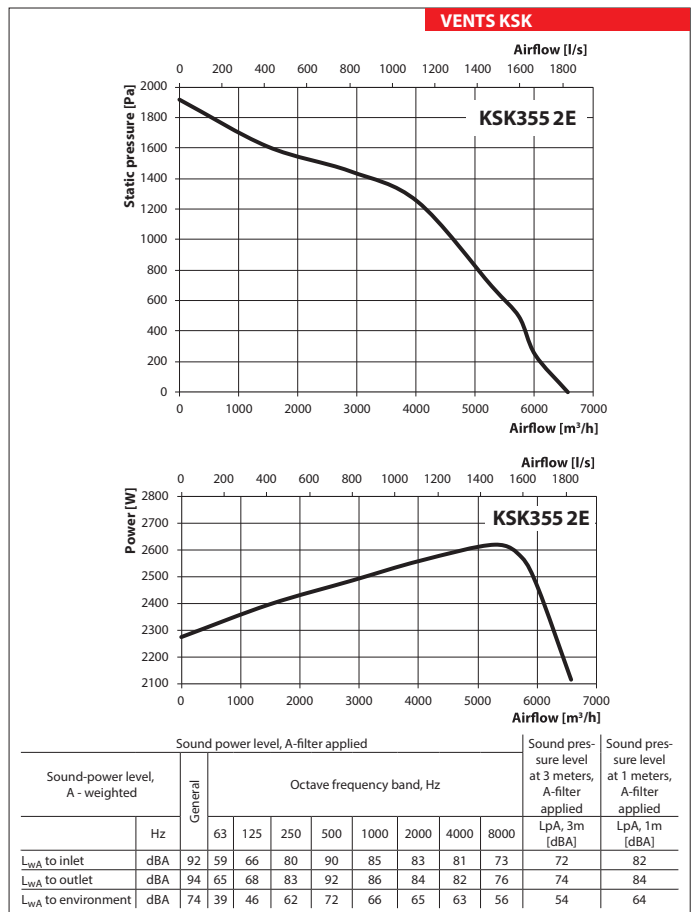

FAN SERIES VENTS KSK



## SOUND-INSULATED KITCHEN FAN

	<b>KSK 355 2D</b>
Voltage [V/Hz]	400/50
Power [W]	3145
Current [A]	6.12
Maximum air flow [m <sup>3</sup> /h]	6185
RPM [min <sup>-1</sup> ]	2652
Noise level at 3 m [dBA]	54
Maximum operating temperature [°C]	-20...+120
Protection rating	IP54

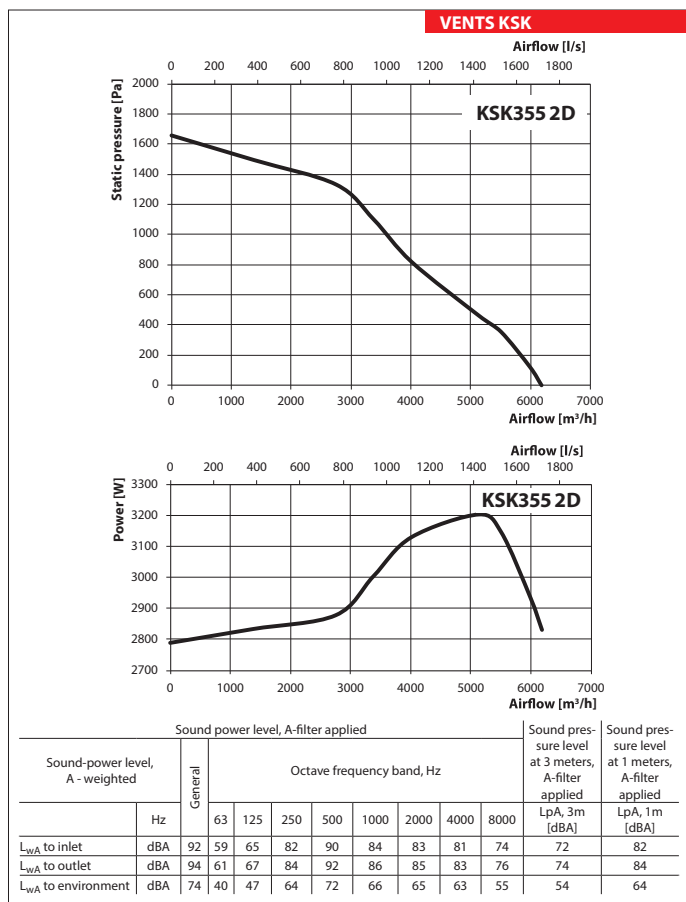

	<b>KSK 400 4E</b>
Voltage [V/Hz]	230/50
Power [W]	1048
Current [A]	5,00
Maximum air flow [m <sup>3</sup> /h]	5392
RPM [min <sup>-1</sup> ]	1440
Noise level at 3 m [dBA]	54
Maximum operating temperature [°C]	-20...+120
Protection rating	IP 54

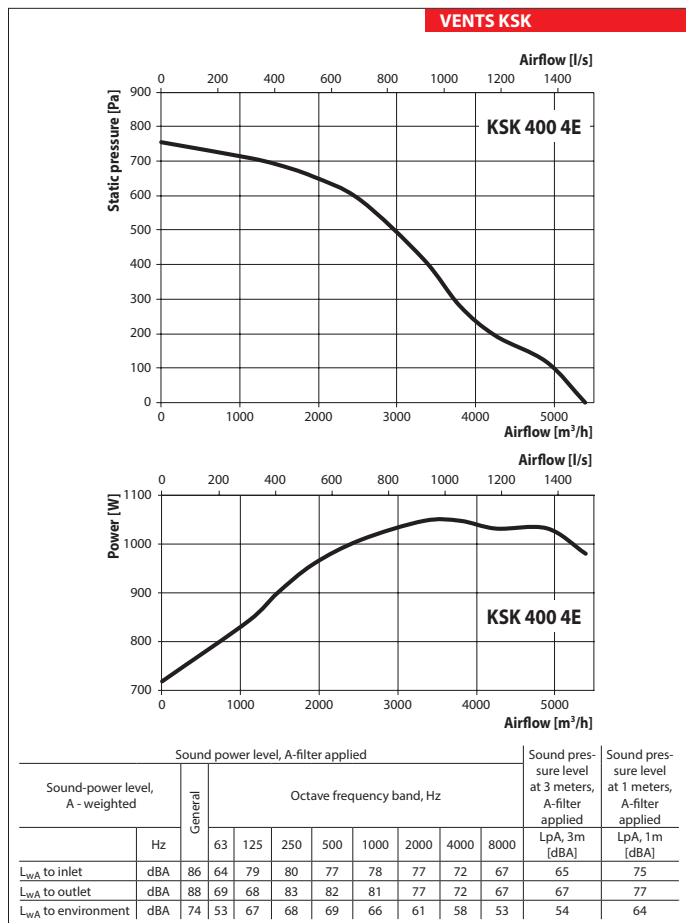

	<b>KSK 400 4D</b>
Voltage [V/Hz]	400/50
Power [W]	785
Current [A]	2.25
Maximum air flow [m <sup>3</sup> /h]	5098
RPM [min <sup>-1</sup> ]	1470
Noise level at 3 m [dBA]	53
Maximum operating temperature [°C]	-20...+120
Protection rating	IP 54

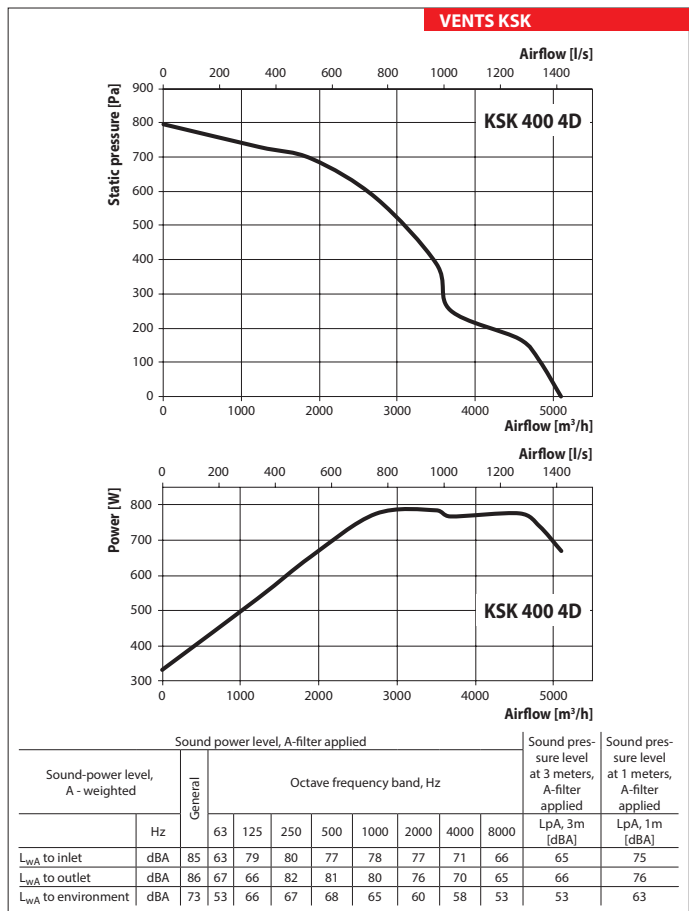

	<b>KSK 400 6E</b>
Voltage [V/Hz]	230/50
Power [W]	362
Current [A]	1.71
Maximum air flow [m <sup>3</sup> /h]	2915
RPM [min <sup>-1</sup> ]	930
Noise level at 3 m [dBA]	48
Maximum operating temperature [°C]	-20...+120
Protection rating	IP 54

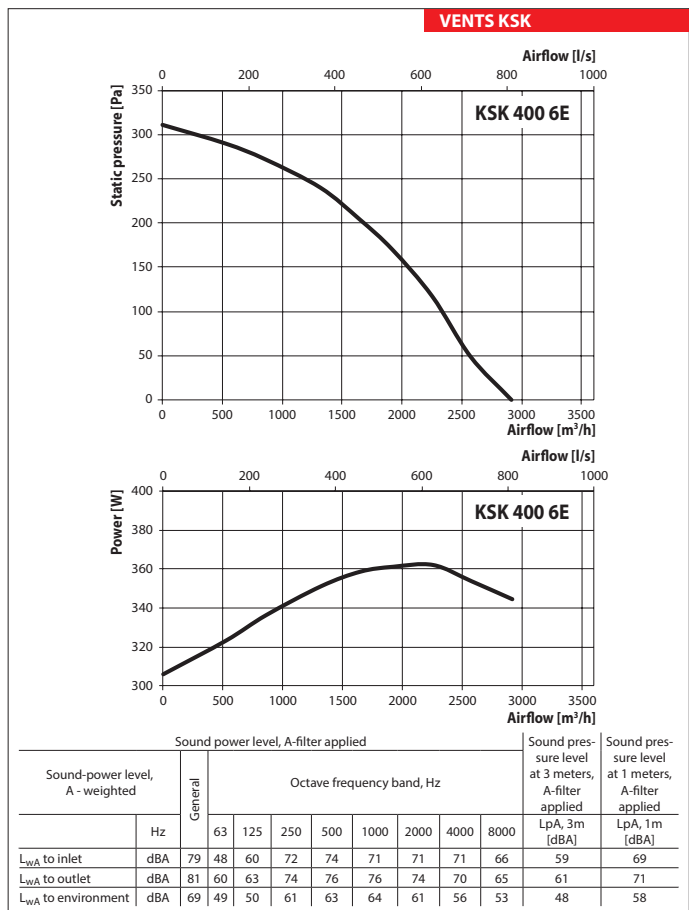

FAN SERIES VENTS KSK



	<b>KSK 400 6D</b>
Voltage [V/Hz]	400/50
Power [W]	357
Current [A]	0.92
Maximum air flow [m <sup>3</sup> /h]	2966
RPM [min <sup>-1</sup> ]	948
Noise level at 3 m [dBA]	47
Maximum operating temperature [°C]	-20...+120
Protection rating	IP 54

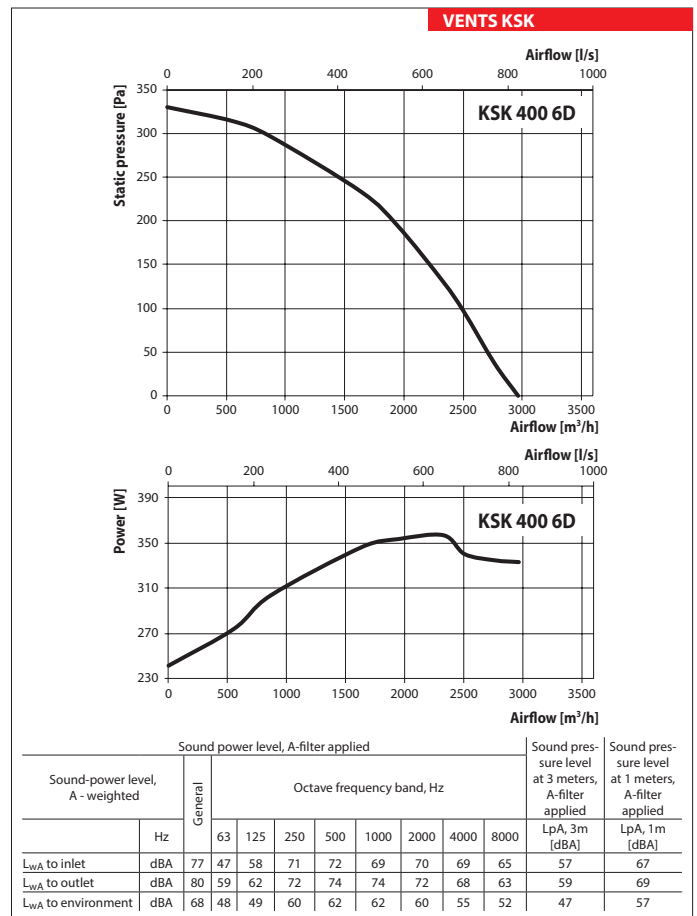

	<b>KSK 450 4E</b>
Voltage [V/Hz]	230/50
Power [W]	1570
Current [A]	7.25
Maximum air flow [m <sup>3</sup> /h]	8138
RPM [min <sup>-1</sup> ]	1470
Noise level at 3 m [dBA]	57
Maximum operating temperature [°C]	-20...+120
Protection rating	IP 54

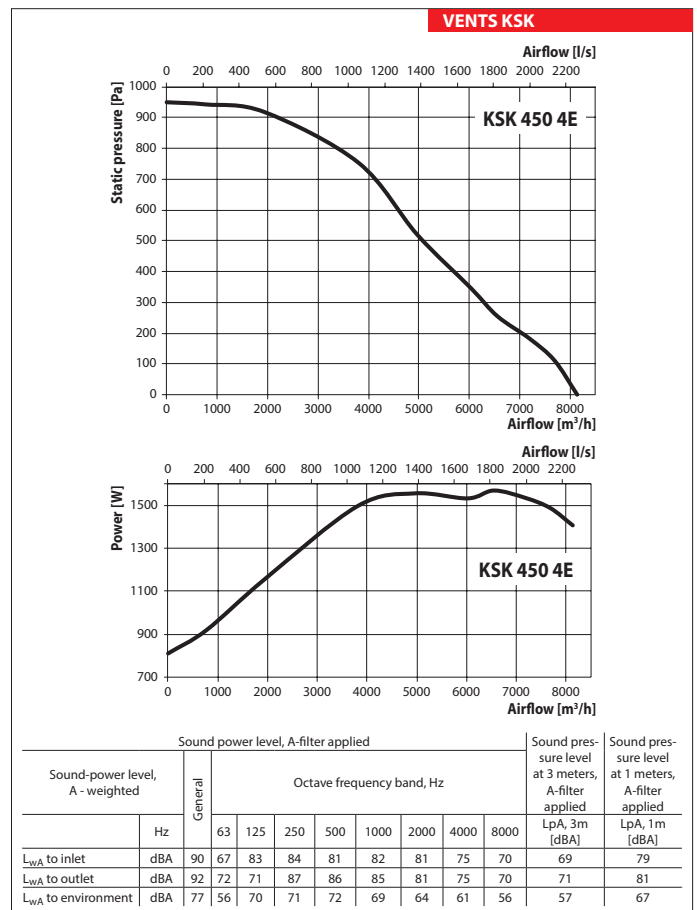

	<b>KSK 450 4D</b>
Voltage [V/Hz]	400/50
Power [W]	1350
Current [A]	2.81
Maximum air flow [m³/h]	7840
RPM [min <sup>-1</sup> ]	1450
Noise level at 3 m [dBA]	56
Maximum operating temperature [°C]	-20...+120
Protection rating	IP 54

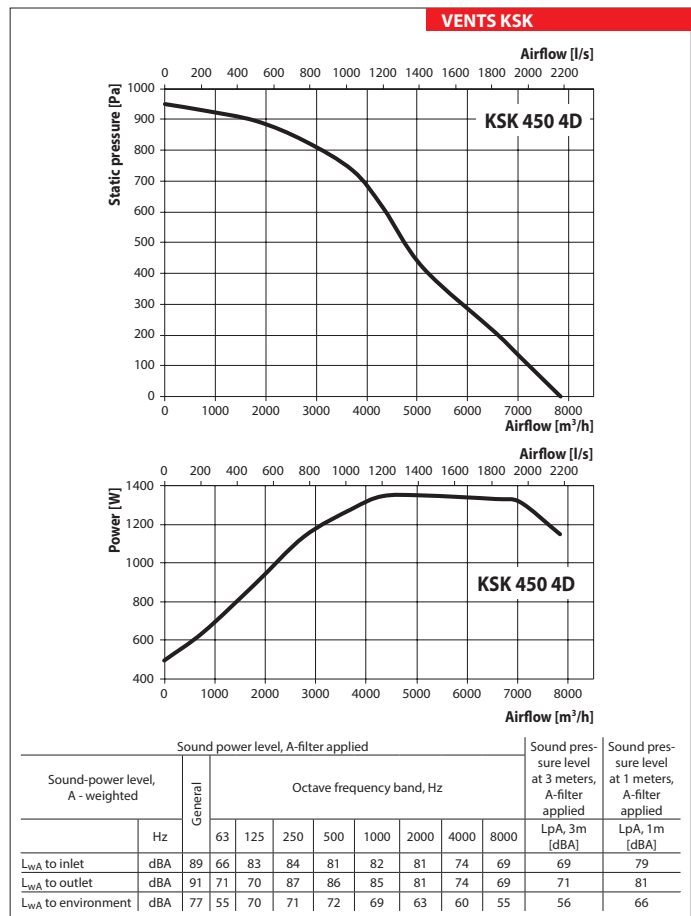

FAN SERIES VENTS KSK

	<b>KSK 450 6E</b>
Voltage [V/Hz]	230/50
Power [W]	594
Current [A]	2.85
Maximum air flow [m³/h]	5299
RPM [min <sup>-1</sup> ]	970
Noise level at 3 m [dBA]	50
Maximum operating temperature [°C]	-20...+120
Protection rating	IP 54

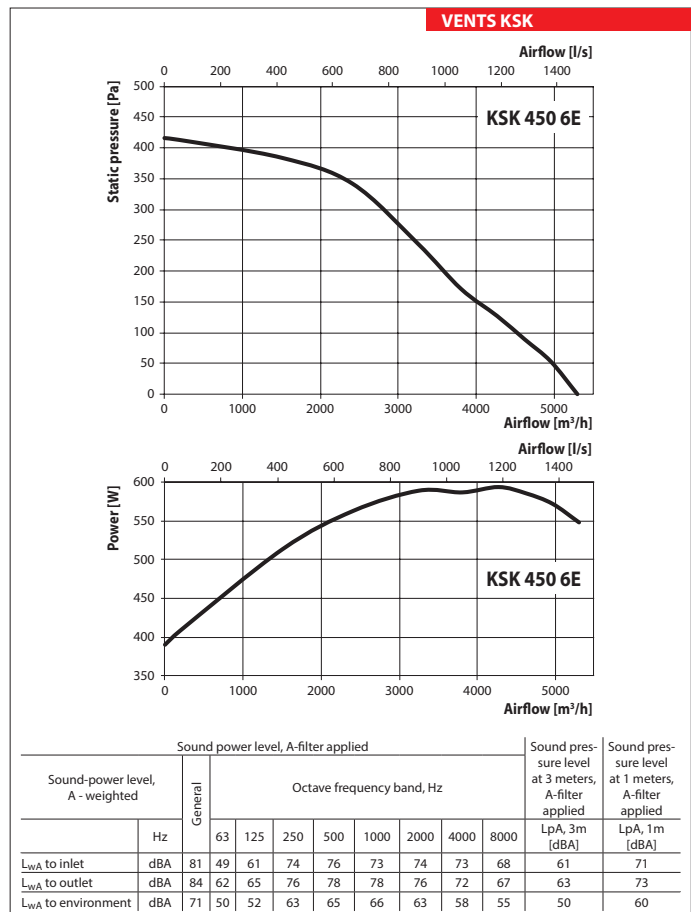

	<b>KSK 450 6D</b>
Voltage [V/Hz]	400/50
Power [W]	454
Current [A]	1.33
Maximum air flow [m <sup>3</sup> /h]	4991
RPM [min <sup>-1</sup> ]	920
Noise level at 3 m [dBA]	49
Maximum operating temperature [°C]	-20...+120
Protection rating	IP 54

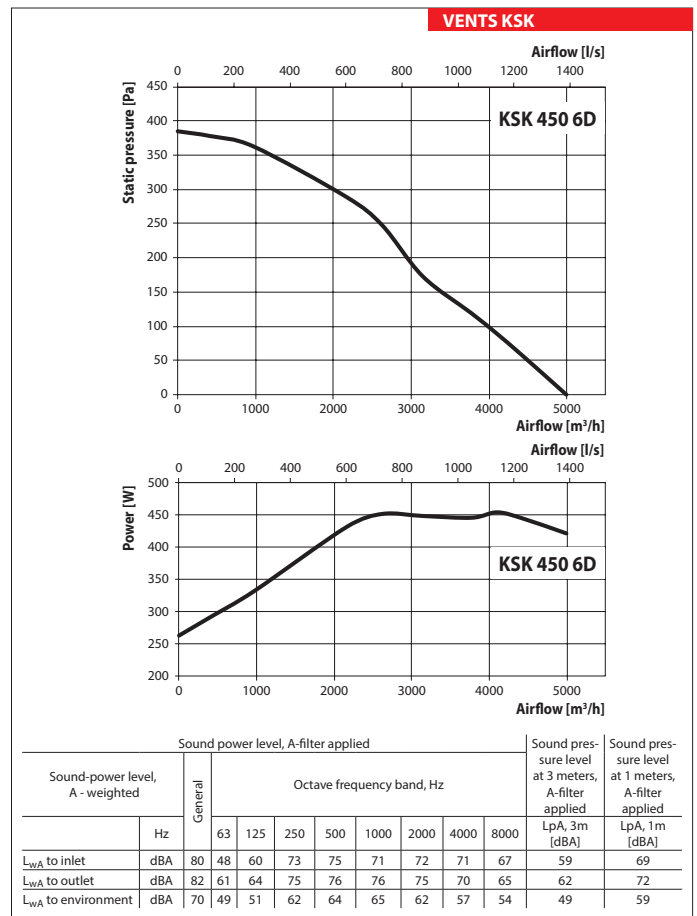

**Fan overall dimensions**

Type	Dimensions [mm]										Weight [kg]
	∅D	B	B1	H	H1	L	L1	L2	L3	L4	
KSK 150 4E	150	410	330	540	365	525	500	470	475	205	17
KSK 150 4D	150	410	330	540	365	525	500	470	475	205	17
KSK 160 4E	160	410	330	540	365	525	500	470	475	205	17
KSK 160 4D	160	410	330	540	365	525	500	470	475	205	17
KSK 200 4E	200	485	365	600	425	625	600	570	515	235	25
KSK 200 4D	200	485	365	600	425	625	600	570	515	235	25
KSK 250 4E	250	575	435	665	505	700	675	645	620	285	40
KSK 250 4D	250	575	435	665	505	700	675	645	620	285	40
KSK 315 4E	315	690	550	708	600	715	700	650	612	327	53
KSK 315 4D	315	690	550	708	600	715	700	650	612	327	52
KSK 315 2E	315	690	550	708	600	715	700	650	672	327	61
KSK 315 2D	315	690	550	708	600	715	700	650	672	327	60
KSK 355 4E	355	740	600	764	655	727	700	650	637	352	60
KSK 355 4D	355	740	600	764	655	727	700	650	637	352	59
KSK 355 2E	355	740	600	764	655	727	700	650	737	352	68
KSK 355 2D	355	740	600	764	655	727	700	650	737	352	65
KSK 400 4E	400	906	700	900	790	908	900	850	747	402	92
KSK 400 4D	400	906	700	900	790	908	900	850	747	402	92
KSK 400 6E	400	906	700	900	790	908	900	850	687	402	87
KSK 400 6D	400	906	700	900	790	908	900	850	687	402	87
KSK 450 4E	450	996	750	980	870	925	900	850	782	437	109
KSK 450 4D	450	996	750	980	870	925	900	850	782	437	109
KSK 450 6E	450	996	750	980	870	925	900	850	739	437	105
KSK 450 6D	450	996	750	980	870	925	900	850	739	437	105

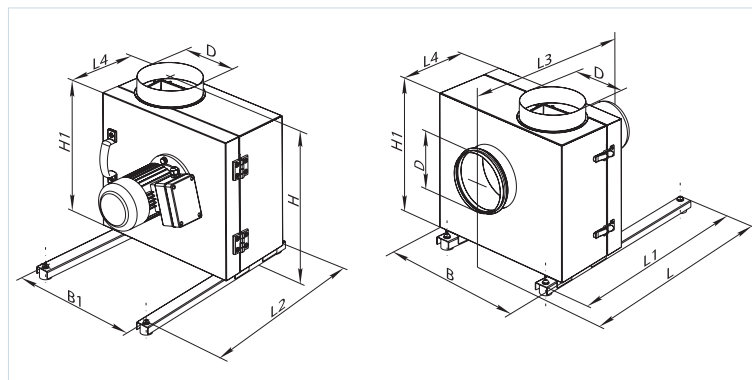

FAN SERIES VENTS KSK